

## ARPL-3W GREEN (2G3N)



### FEATURES

- Long operating life
- Highest flux
- Lambertian radiation pattern
- More energy efficient than incandescent and most halogen lamps
- Low voltage DC operated
- Cool beam, safe to the touch
- Instant light (less than 100ns )
- Fully dimmable
- No UV
- Superior ESD protection
- RoHS compliant

### APPLICATIONS

- Fiber optic alternative/Decorative/entertainment
- Mini-acct/Up lighters/Down lighters/Orientation
- Indoor/Outdoor commercial and Residential Architectural
- Cove/Under shelf/Task
- Bollards/Security/Garden
- Portable(flashlight,bicycle)
- Edge-lit signs (Exit,point of sale)
- Automotive Exit (Stop-Tail-Tum, Chmsl, Mirror Side Repeat)
- Traffic signaling/Beacons/RailCrossing and Wayside

### RADIATION PATTERN

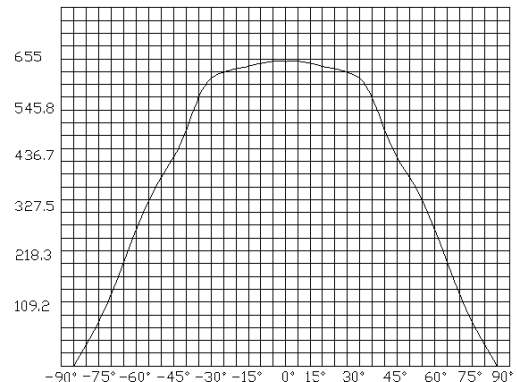
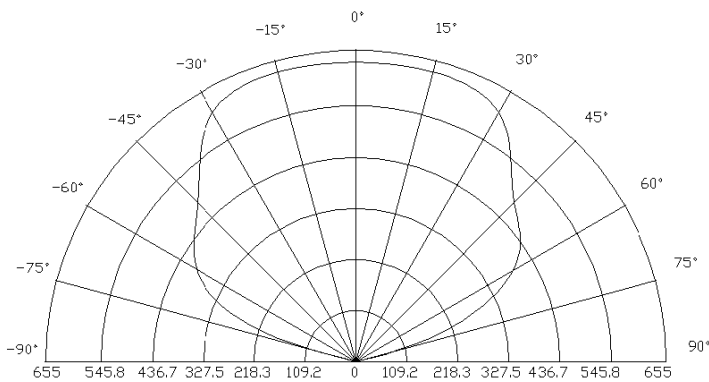

### ELECTRICAL / OPTICAL CHARACTERISTICS AT TA=25°C

Item	Symbol	Condition	Min.	Typ.	Max.	Unit
Forward Voltage	$V_F (R)$	IF=700mA	3.4	--	3.6	V
Reverse Current	$I_R$	VR=5V	--	--	30	uA
50% Power Angle	$2\theta_{1/2}$	IF=700mA	120		140	deg
Luminous Intensity	$\phi_V (R)$	IF=700mA	170		190	lm
Recommend Forward Current	$I_F$	-	-	-	700	mA
Wave Length	$\lambda_d$	IF=700mA	520		530	nm
Thermal Resistance, Junction to Case	RJP	IF=700mA	--	10	--	°C/w

#### Notes:

1. Tolerance of measurement of forward voltage  $\pm 0.1V$ .
2. Tolerance of measurement of peak Wavelength  $\pm 2.0nm$ .
3. Tolerance of measurement of luminous intensity  $\pm 15\%$ .

## ABSOLUTE MAXIMUM RATING

Item	Symbol	Absolute Maximum Rating	Unit
Forward Current	$I_F$	700	mA
Peak Forward Current*	$I_{FP}$	1000	mA
Reverse Voltage	$V_R$	5	V
Power Dissipation	$P_D$	3000	mW
Electrostatic discharge	$E_{SD}$	$\pm 2000$	V
Operation Temperature	$T_{OPR}$	-40~+80	$^{\circ}C$
Storage Temperature	$T_{STG}$	-40~+100	$^{\circ}C$
Lead Soldering Temperature*	$T_{SOL}$	Max. 260 $^{\circ}C$ for 3sec Max.	

\*IFP Conditions: Pulse Width $\leq 10$ msec duty $\leq 1/10$

\* All high power emitter LED products mounted on aluminum metal-core printed circuit board, can be lighted directly, but we do not recommend lighting the high power products for more than 5 seconds without a appropriate heat dissipation equipment.

\* Re-flow, wave peak and soak-stannum soldering etc.is not suitable for this products.

\* Suggest to solder it by professional high power LED soldering machine.

\* Can use invariable-temperature searing-iron with soldering condition:  $\leq 260$  degree less than 3 seconds.

## TYPICAL OPTICAL/ELECTRICAL CHARACTERISTICS CURVES

( $T_a=25^{\circ}C$  Unless Otherwise Noted)

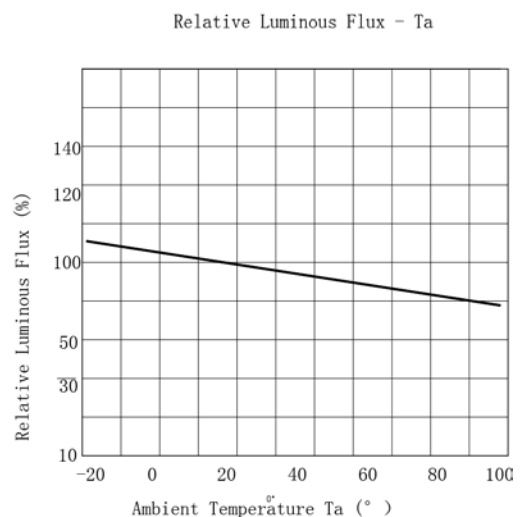
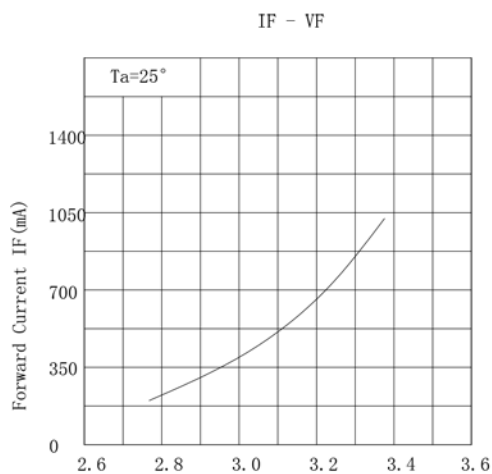
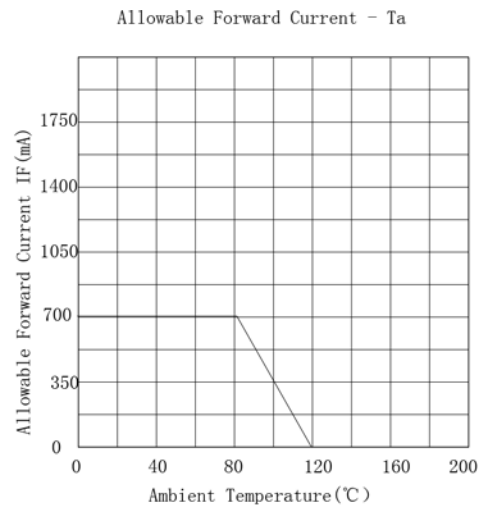
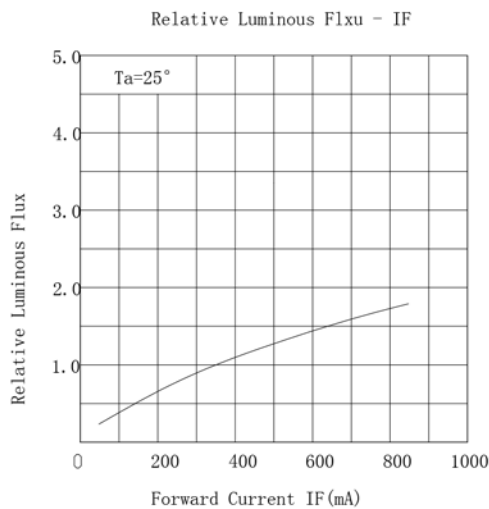

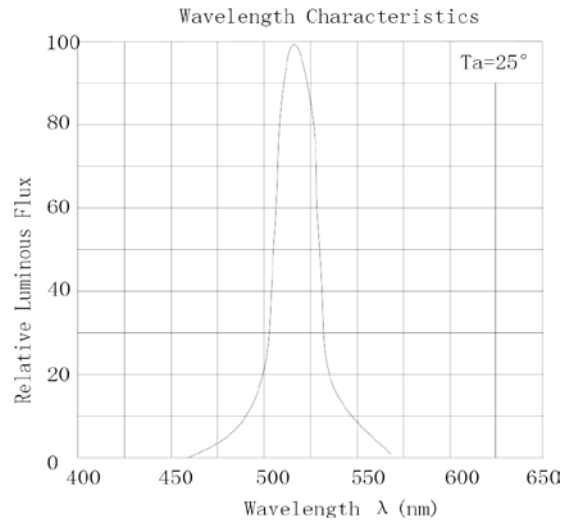

## PACKAGE DIMENSIONS

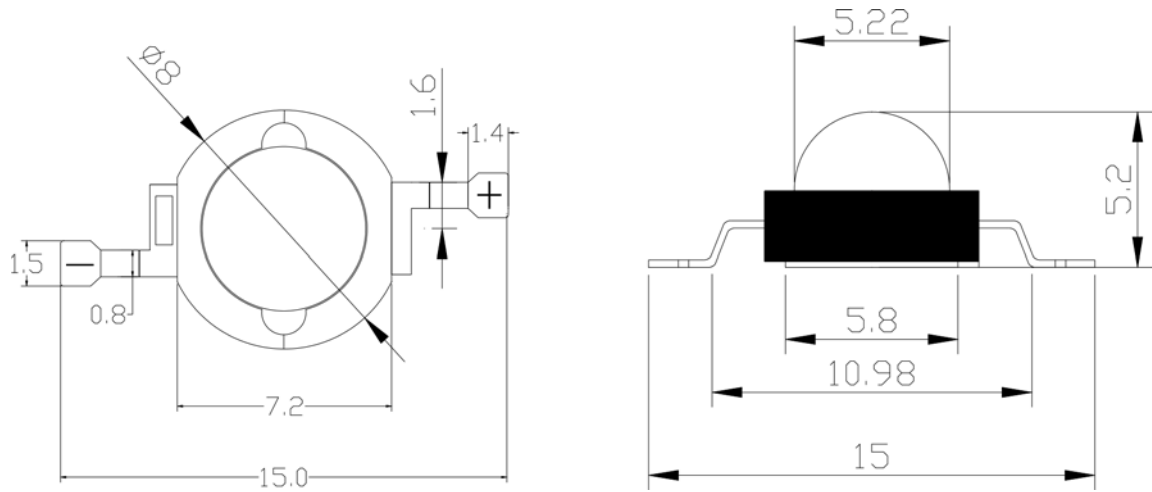

### Notes:

1. All dimension units are millimeters.
2. All dimension tolerance is  $\pm 0.2\text{mm}$  unless otherwise noted.

